



32-Kb I²C CMOS Serial EEPROM



FEATURES

- Supports Standard and Fast I²C Protocol
- 1.7V to 5.5V Supply Voltage Range
- 32-Byte Page Write Buffer
- Hardware Write Protection for entire memory
- Schmitt Triggers and Noise Suppression Filters on I²C Bus Inputs (SCL and SDA)
- Low power CMOS technology
- 1,000,000 program/erase cycles
- 100 year data retention
- Industrial and Extended temperature range
- RoHS-compliant PDIP, SOIC, TSSOP, TDFN and UDFN 8-lead packages

DEVICE DESCRIPTION

The CAT24C32 is a 32-Kb CMOS Serial EEPROM devices, internally organized as 128 pages of 32 bytes each.

It features a 32-byte page write buffer and supports both the Standard (100kHz) as well as Fast (400kHz) I²C protocol.

External address pins make it possible to address up to eight CAT24C32 devices on the same bus.

For Ordering Information details, see page 16.



PIN CONFIGURATION

PDIP (L), SOIC (W), TSSOP (Y)
TDFN (VP2), UDFN (HU3)

A ₀	1	8	V _{CC}
A ₁	2	7	WP
A ₂	3	6	SCL
V _{SS}	4	5	SDA

Note: For the location of Pin 1, please consult the corresponding package drawing.

PIN FUNCTIONS

Name	Description
A ₀ , A ₁ , A ₂	Device Address
SDA	Serial Data
SCL	Serial Clock
WP	Write Protect
V _{CC}	Power Supply
V _{SS}	Ground

FUNCTIONAL SYMBOL

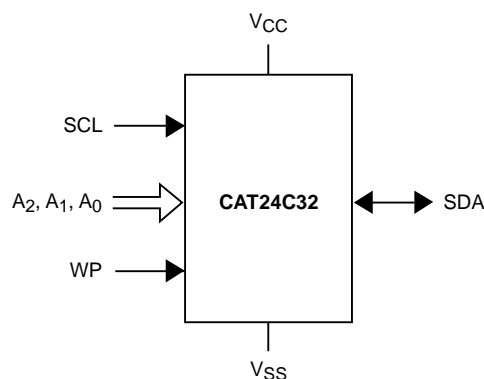

Notes:

- * Catalyst carries the I²C protocol under a license from the Philips Corporation.
- ** The Green & Gold seal identifies RoHS-compliant packaging, using NiPdAu pre-plated lead frames.

CAT24C32

ABSOLUTE MAXIMUM RATINGS⁽¹⁾

Storage Temperature	-65°C to +150°C
Voltage on any pin with respect to Ground ⁽²⁾	-0.5V to +6.5V

RELIABILITY CHARACTERISTICS⁽³⁾

Symbol	Parameter	Min	Units
$N_{END}^{(4)}$	Endurance	1,000,000	Program/Erase Cycles
T_{DR}	Data Retention	100	Years

D.C. OPERATING CHARACTERISTICS

$V_{CC} = 1.8V$ to $5.5V$, $T_A = -40°C$ to $+125°C$ and $V_{CC} = 1.7V$ to $5.5V$, $T_A = -20°C$ to $+85°C$, unless otherwise specified.

Symbol	Parameter	Test Conditions	Min	Max	Units
I_{CCR}	Read Current	Read, $f_{SCL} = 400kHz$		1	mA
I_{CCW}	Write Current	Write, $f_{SCL} = 400kHz$		2	mA
I_{SB}	Standby Current	All I/O Pins at GND or V_{CC}	$T_A = -40°C$ to $+85°C$	1	μA
			$T_A = -40°C$ to $+125°C$	2	
I_L	I/O Pin Leakage	Pin at GND or V_{CC}	$T_A = -40°C$ to $+85°C$	1	μA
			$T_A = -40°C$ to $+125°C$	2	
V_{IL}	Input Low Voltage		-0.5	$V_{CC} \times 0.3$	V
V_{IH}	Input High Voltage		$V_{CC} \times 0.7$	$V_{CC} + 0.5$	V
V_{OL1}	Output Low Voltage	$V_{CC} < 2.5V$, $I_{OL} = 3.0mA$		0.4	V
V_{OL2}	Output Low Voltage	$V_{CC} < 2.5V$, $I_{OL} = 1.0mA$		0.2	V

PIN IMPEDANCE CHARACTERISTICS

$V_{CC} = 1.8V$ to $5.5V$, $T_A = -40°C$ to $+125°C$ and $V_{CC} = 1.7V$ to $5.5V$, $T_A = -20°C$ to $+85°C$, unless otherwise specified.

Symbol	Parameter	Conditions	Max	Units
$C_{IN}^{(3)}$	SDA I/O Pin Capacitance	$V_{IN} = 0V$, $T_A = 25°C$, $f = 1.0MHz$	8	pF
$C_{IN}^{(3)}$	Input Capacitance (other pins)	$V_{IN} = 0V$, $T_A = 25°C$, $f = 1.0MHz$	6	pF
$I_{WP}^{(5)}$	WP Input Current	$V_{IN} < V_{IH}$	200	μA
		$V_{IN} > V_{IH}$	1	

Notes:

- (1) Stresses above those listed under "Absolute Maximum Ratings" may cause permanent damage to the device. These are stress ratings only, and functional operation of the device at these or any other conditions outside of those listed in the operational sections of this specification is not implied. Exposure to any absolute maximum rating for extended periods may affect device performance and reliability.
- (2) The DC input voltage on any pin should not be lower than -0.5V or higher than $V_{CC} + 0.5V$. During transitions, the voltage on any pin may undershoot to no less than -1.5V or overshoot to no more than $V_{CC} + 1.5V$, for periods of less than 20ns.
- (3) These parameters are tested initially and after a design or process change that affects the parameter according to appropriate AEC-Q100 and JEDEC test methods.
- (4) Page Mode, $V_{CC} = 5V$, $25°C$.
- (5) When not driven, the WP pin is pulled down to GND internally. For improved noise immunity, the internal pull-down is relatively strong; therefore the external driver must be able to supply the pull-down current when attempting to drive the input HIGH. To conserve power, as the input level exceeds the trip point of the CMOS input buffer ($\sim 0.5 \times V_{CC}$), the strong pull-down reverts to a weak current source.

A.C. CHARACTERISTICS⁽¹⁾

$V_{CC} = 1.8V$ to $5.5V$, $T_A = -40^{\circ}C$ to $+125^{\circ}C$ and $V_{CC} = 1.7V$ to $5.5V$, $T_A = -20^{\circ}C$ to $+85^{\circ}C$, unless otherwise specified.

Symbol	Parameter	Standard		Fast		Units
		Min	Max	Min	Max	
F_{SCL}	Clock Frequency		100		400	kHz
$t_{HD:STA}$	START Condition Hold Time	4		0.6		μs
t_{LOW}	Low Period of SCL Clock	4.7		1.3		μs
t_{HIGH}	High Period of SCL Clock	4		0.6		μs
$t_{SU:STA}$	START Condition Setup Time	4.7		0.6		μs
$t_{HD:DAT}$	Data In Hold Time	0		0		μs
$t_{SU:DAT}$	Data In Setup Time	250		100		ns
t_R	SDA and SCL Rise Time		1000		300	ns
$t_F^{(2)}$	SDA and SCL Fall Time		300		300	ns
$t_{SU:STO}$	STOP Condition Setup Time	4		0.6		μs
t_{BUF}	Bus Free Time Between STOP and START	4.7		1.3		μs
t_{AA}	SCL Low to Data Out Valid		3.5		0.9	μs
t_{DH}	Data Out Hold Time	100		100		ns
$T^{(2)}$	Noise Pulse Filtered at SCL and SDA Inputs		100		100	ns
$t_{SU:WP}$	WP Setup Time	0		0		μs
$t_{HD:WP}$	WP Hold Time	2.5		2.5		μs
t_{WR}	Write Cycle Time		5		5	ms
$t_{PU}^{(2, 3)}$	Power-up to Ready Mode		1		1	ms

A.C. TEST CONDITIONS

Input Drive Levels	$0.2 \times V_{CC}$ to $0.8 \times V_{CC}$
Input Rise and Fall Time	$\leq 50ns$
Input Reference Levels	$0.3 \times V_{CC}$, $0.7 \times V_{CC}$
Output Reference Level	$0.5 \times V_{CC}$
Output Test Load	Current Source $I_{OL} = 3mA$ ($V_{CC} \geq 2.5V$); $I_{OL} = 1mA$ ($V_{CC} < 2.5V$); $C_L = 100pF$

Notes:

- (1) Test conditions according to "A.C. Test Conditions" table.
- (2) Tested initially and after a design or process change that affects this parameter.
- (3) t_{PU} is the delay between the time V_{CC} is stable and the device is ready to accept commands.

POWER-ON RESET (POR)

Each CAT24C32 incorporates Power-On Reset (POR) circuitry which protects the internal logic against powering up in the wrong state. The device will power up into Standby mode after V_{CC} exceeds the POR trigger level and will power down into Reset mode when V_{CC} drops below the POR trigger level. This bi-directional POR behavior protects the device against 'brown-out' failure following a temporary loss of power.

PIN DESCRIPTION

SCL: The Serial Clock input pin accepts the clock signal generated by the Master.

SDA: The Serial Data I/O pin accepts input data and delivers output data. In transmit mode, this pin is open drain. Data is acquired on the positive edge, and is delivered on the negative edge of SCL.

A₀, A₁ and A₂: The Address inputs set the device address that must be matched by the corresponding Slave address bits. The Address inputs are hard-wired HIGH or LOW allowing for up to eight devices to be used (cascaded) on the same bus. When left floating, these pins are pulled LOW internally.

WP: When pulled HIGH, the Write Protect input pin inhibits all write operations. When left floating, this pin is pulled LOW internally.

FUNCTIONAL DESCRIPTION

The CAT24C32 supports the Inter-Integrated Circuit (I²C) Bus protocol. The protocol relies on the use of a Master device, which provides the clock and directs bus traffic, and Slave devices which execute requests. The CAT24C32 operates as a Slave device. Both Master and Slave can transmit or receive, but only the Master can assign those roles.

I²C BUS PROTOCOL

The 2-wire I²C bus consists of two lines, SCL and SDA, connected to the V_{CC} supply via pull-up resistors. The Master provides the clock to the SCL line, and either the Master or the Slaves drive the SDA line. A '0' is transmitted by pulling a line LOW and a '1' by letting it stay HIGH. Data transfer may be initiated only when the bus is not busy (see A.C. Characteristics). During data transfer, SDA must remain stable while SCL is HIGH.

START/STOP Condition

An SDA transition while SCL is HIGH creates a START or STOP condition (Figure 1). The START consists of a HIGH to LOW SDA transition, while SCL is HIGH. Absent the START, a Slave will not respond to the Master. The STOP completes all commands, and consists of a LOW to HIGH SDA transition, while SCL is HIGH.

Device Addressing

The Master addresses a Slave by creating a START condition and then broadcasting an 8-bit Slave address. For the CAT24C32, the first four bits of the Slave address are set to 1010 (Ah); the next three bits, A₂, A₁ and A₀, must match the logic state of the similarly named input pins. The R/W bit tells the Slave whether the Master intends to read (1) or write (0) data (Figure 2).

Acknowledge

During the 9th clock cycle following every byte sent to the bus, the transmitter releases the SDA line, allowing the receiver to respond. The receiver then either acknowledges (ACK) by pulling SDA LOW, or does not acknowledge (NoACK) by letting SDA stay HIGH (Figure 3). Bus timing is illustrated in Figure 4.

Figure 1. Start/Stop Timing

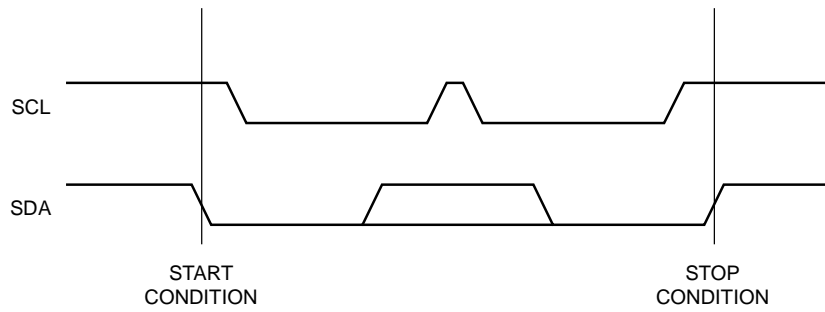

Figure 2. Slave Address Bits

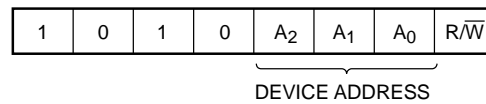

Figure 3. Acknowledge Timing

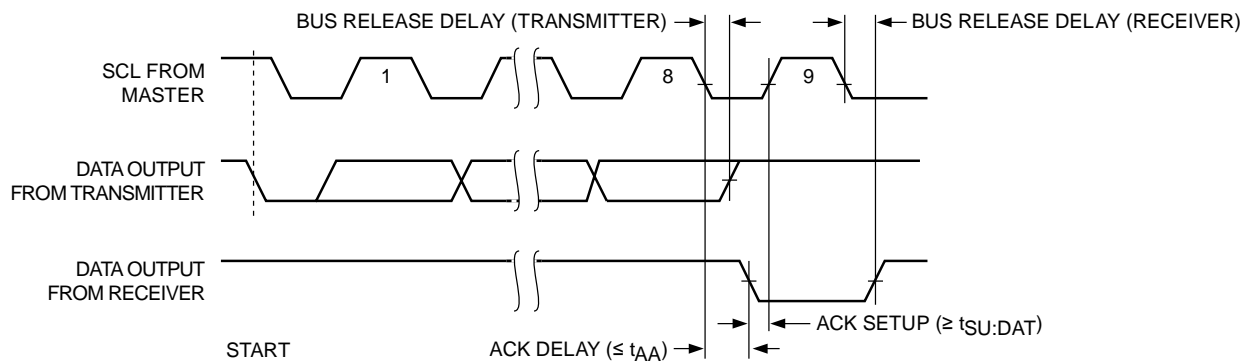
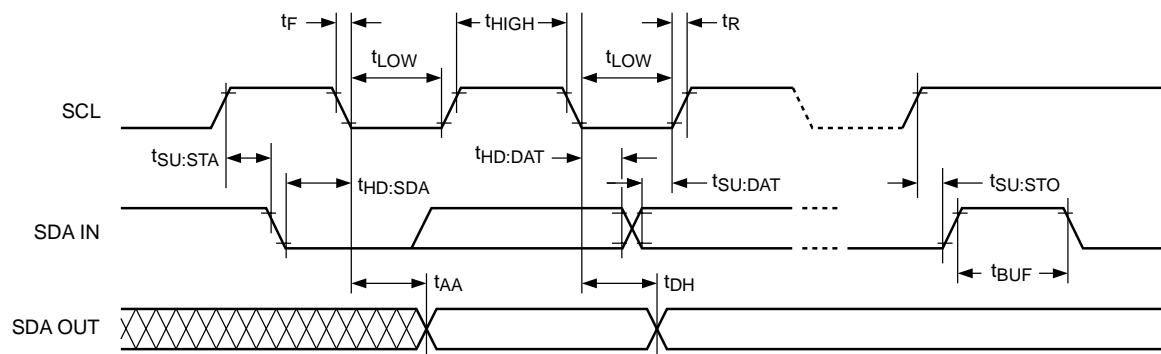

Figure 4. Bus Timing



WRITE OPERATIONS

Byte Write

To write data to memory, the Master creates a START condition on the bus and then broadcasts a Slave address with the R/W bit set to '0'. The Master then sends two address bytes and a data byte and concludes the session by creating a STOP condition on the bus. The Slave responds with ACK after every byte sent by the Master (Figure 5). The STOP starts the internal Write cycle, and while this operation is in progress (t_{WR}), the SDA output is tri-stated and the Slave does not acknowledge the Master (Figure 6).

Page Write

The Byte Write operation can be expanded to Page Write, by sending more than one data byte to the Slave before issuing the STOP condition (Figure 7). Up to 32 distinct data bytes can be loaded into the internal Page Write Buffer starting at the address provided by the Master. The page address is latched, and as long as the Master keeps sending data, the internal byte address is incremented up to the end of page, where it then wraps around (within the page). New data can therefore replace data loaded earlier. Following the STOP, data loaded during the Page Write session will be written to memory in a single internal Write cycle (t_{WR}).

Acknowledge Polling

As soon (and as long) as internal Write is in progress, the Slave will not acknowledge the Master. This feature enables the Master to immediately follow-up with a new Read or Write request, rather than wait for the maximum specified Write time (t_{WR}) to elapse. Upon receiving a NoACK response from the Slave, the Master simply repeats the request until the Slave responds with ACK.

Hardware Write Protection

With the WP pin held HIGH, the entire memory is protected against Write operations. If the WP pin is left floating or is grounded, it has no impact on the Write operation. The state of the WP pin is strobed on the last falling edge of SCL immediately preceding the 1st data byte (Figure 8). If the WP pin is HIGH during the strobe interval, the Slave will not acknowledge the data byte and the Write request will be rejected.

DELIVERY STATE

The CAT24C32 is shipped erased, i.e., all bytes are FFh.

Figure 5. Byte Write Sequence

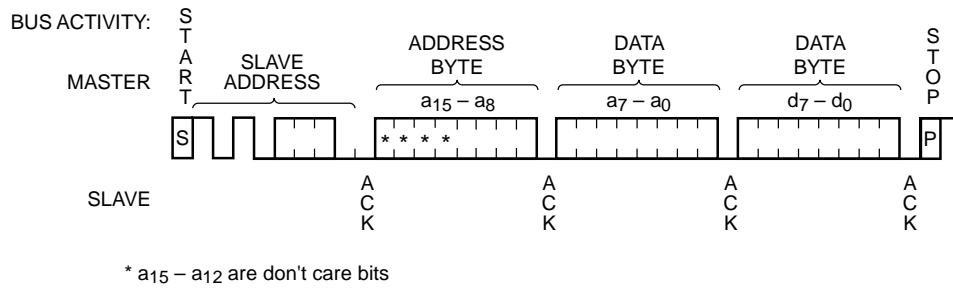

Figure 6. Write Cycle Timing

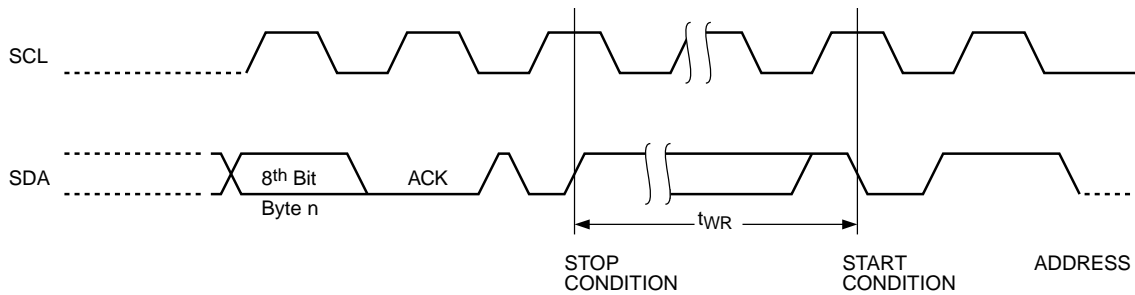

Figure 7. Page Write Sequence

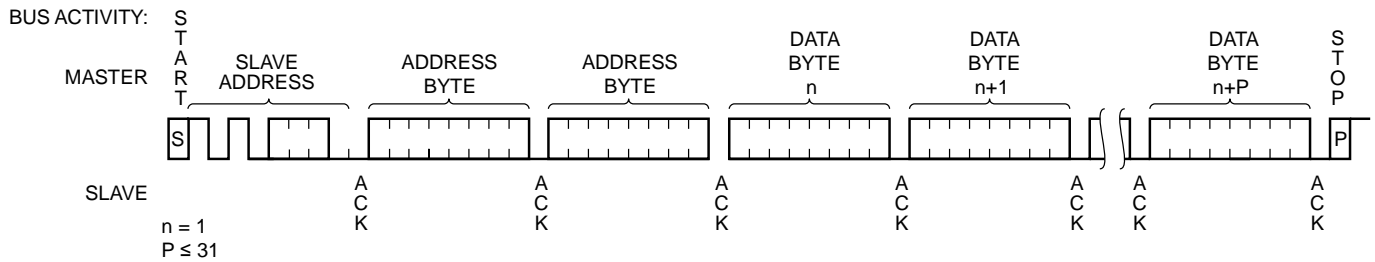
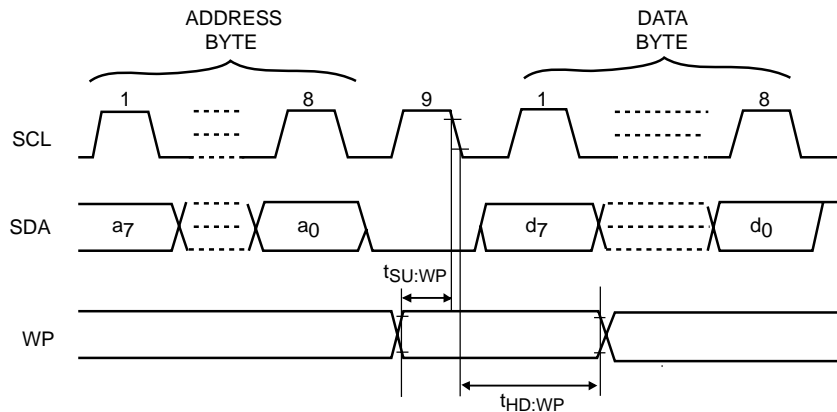

Figure 8. WP Timing



READ OPERATIONS

Immediate Read

To read data from memory, the Master creates a START condition on the bus and then broadcasts a Slave address with the R/W bit set to '1'. The Slave responds with ACK and starts shifting out data residing at the current address. After receiving the data, the Master responds with NoACK and terminates the session by creating a STOP condition on the bus (Figure 9). The Slave then returns to Standby mode.

Selective Read

To read data residing at a specific address, the selected address must first be loaded into the internal address register. This is done by starting a Byte Write sequence, whereby the Master creates a START condition, then broadcasts a Slave address with the R/W bit set to '0' and then sends two address bytes to the Slave. Rather than completing the Byte Write sequence by sending data, the Master then creates a START condition and broadcasts a Slave address with the R/W bit set to '1'. The Slave responds with ACK after every byte sent by the Master and then sends out data residing at the selected address. After receiving the data, the Master responds with NoACK and then terminates the session by creating a STOP condition on the bus (Figure 10).

Sequential Read

If, after receiving data sent by the Slave, the Master responds with ACK, then the Slave will continue transmitting until the Master responds with NoACK followed by STOP (Figure 11). During Sequential Read the internal byte address is automatically incremented up to the end of memory, where it then wraps around to the beginning of memory.

Figure 9. Immediate Read Sequence and Timing

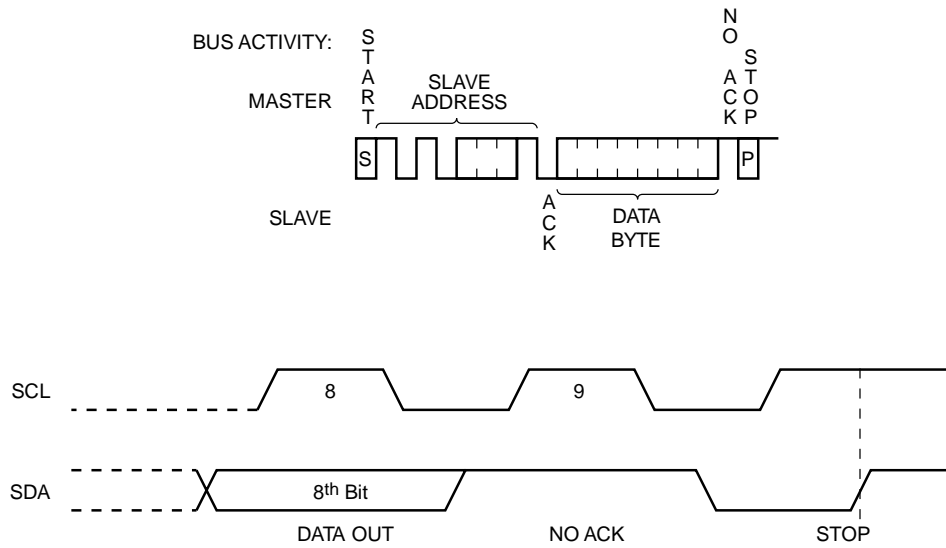

Figure 10. Selective Read Sequence

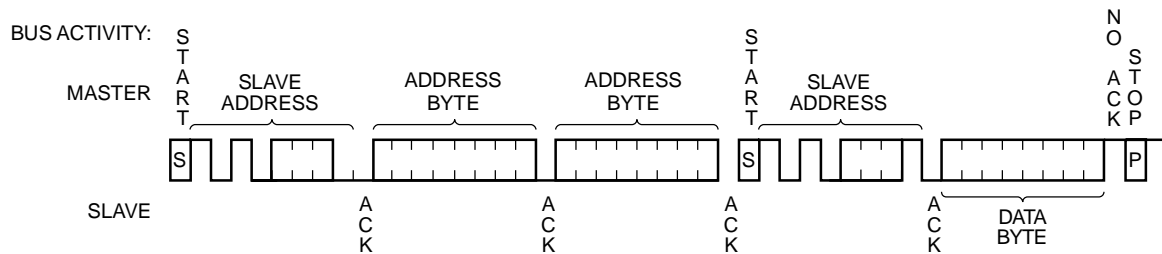
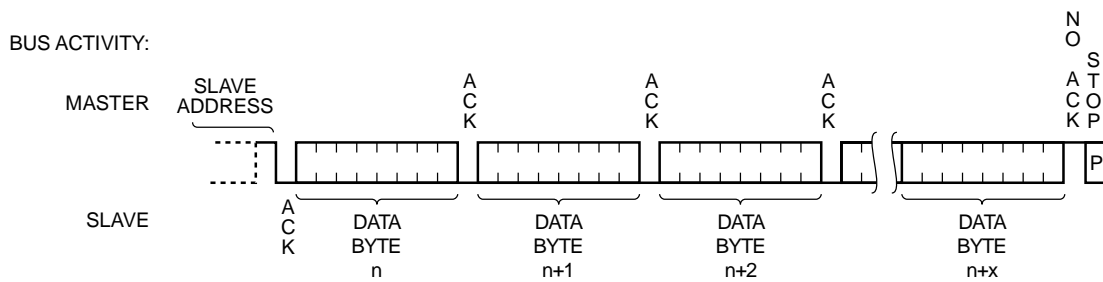
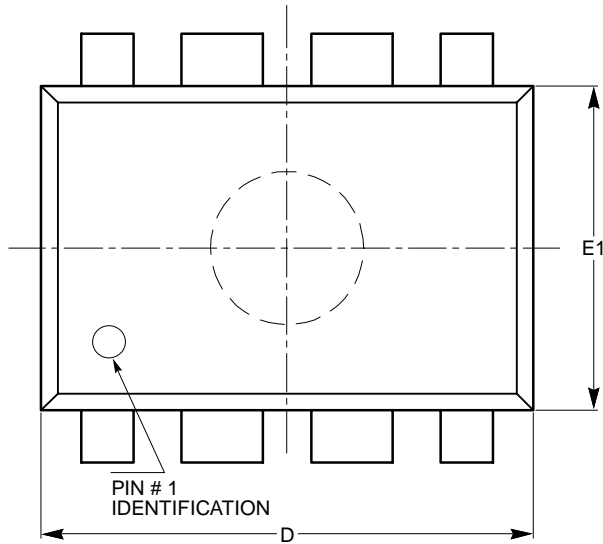

Figure 11. Sequential Read Sequence



PACKAGE OUTLINE DRAWING

PDIP 8-Lead 300mil (L)



SYMBOL	MIN	NOM	MAX
A			5.33
A1	0.38		
A2	2.92	3.30	4.95
b	0.36	0.46	0.56
b2	1.14	1.52	1.78
c	0.20	0.25	0.36
D	9.02	9.27	10.16
E	7.62	7.87	8.25
e	2.54 BSC		
E1	6.10	6.35	7.11
eB	7.87		10.92
L	2.92	3.30	3.80

TOP VIEW

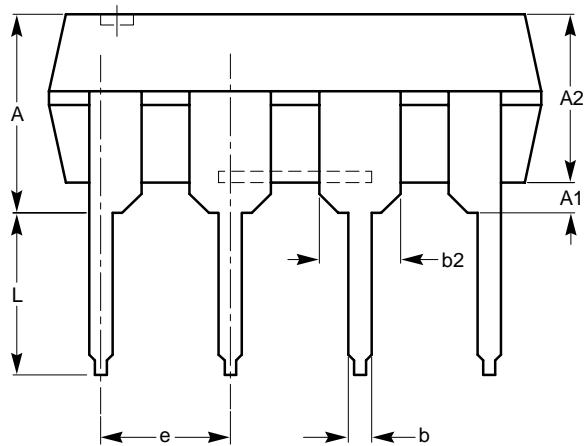

SIDE VIEW

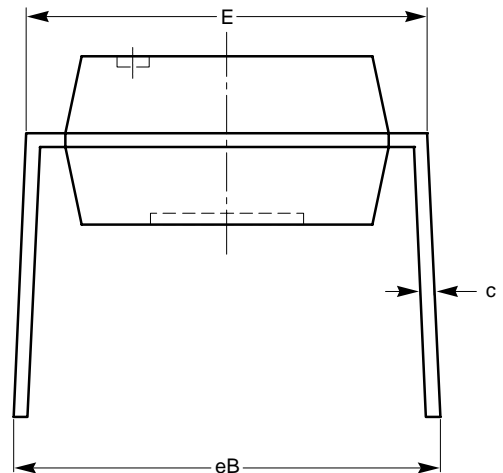

END VIEW

For current Tape and Reel information, download the PDF file from:
<http://www.catsemi.com/documents/tapeandreel.pdf>.

Notes:

- (1) All dimensions are in millimeters.
- (2) Complies with JEDEC standard MS-001.

SOIC 8-Lead 150mil (W)

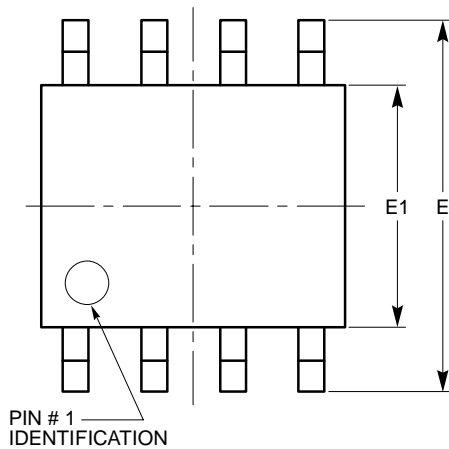

TOP VIEW

SYMBOL	MIN	NOM	MAX
A	1.35		1.75
A1	0.10		0.25
b	0.33		0.51
c	0.19		0.25
D	4.80		5.00
E	5.80		6.20
E1	3.80		4.00
e	1.27 BSC		
h	0.25		0.50
L	0.40		1.27
θ	0°		8°

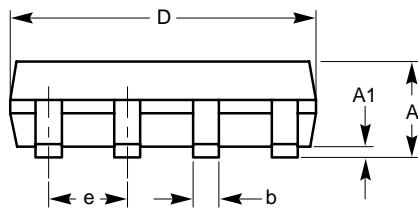

SIDE VIEW

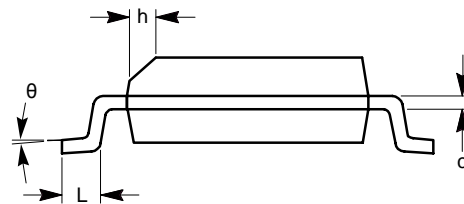

END VIEW

For current Tape and Reel information, download the PDF file from:
<http://www.catsemi.com/documents/tapeandreeel.pdf>.

Notes:

- (1) All dimensions are in millimeters. Angles in degrees.
- (2) Complies with JEDEC standard MS-012.

TSSOP 8-Lead (Y)

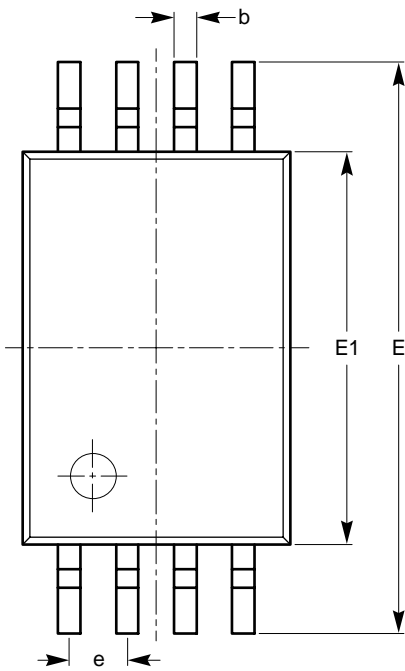

TOP VIEW

SYMBOL	MIN	NOM	MAX
A			1.20
A1	0.05		0.15
A2	0.80	0.90	1.05
b	0.19		0.30
c	0.09		0.20
D	2.90	3.00	3.10
E	6.30	6.40	6.50
E1	4.30	4.40	4.50
e	0.65 BSC		
L	1.00 REF		
L1	0.50	0.60	0.75
$\theta 1$	0°		8°

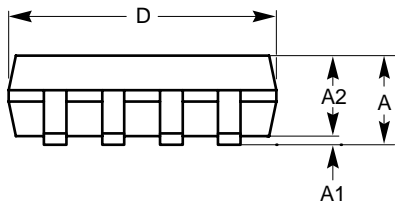

SIDE VIEW

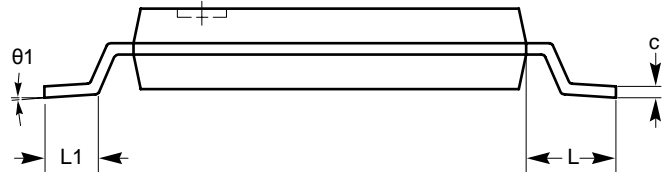

END VIEW

For current Tape and Reel information, download the PDF file from:
<http://www.catsemi.com/documents/tapeandreel.pdf>.

Notes:

- (1) All dimensions are in millimeters. Angles in degrees.
- (2) Complies with JEDEC specification MS-153.

TDFN 8-Pad 3 x 4.9mm (ZD2)

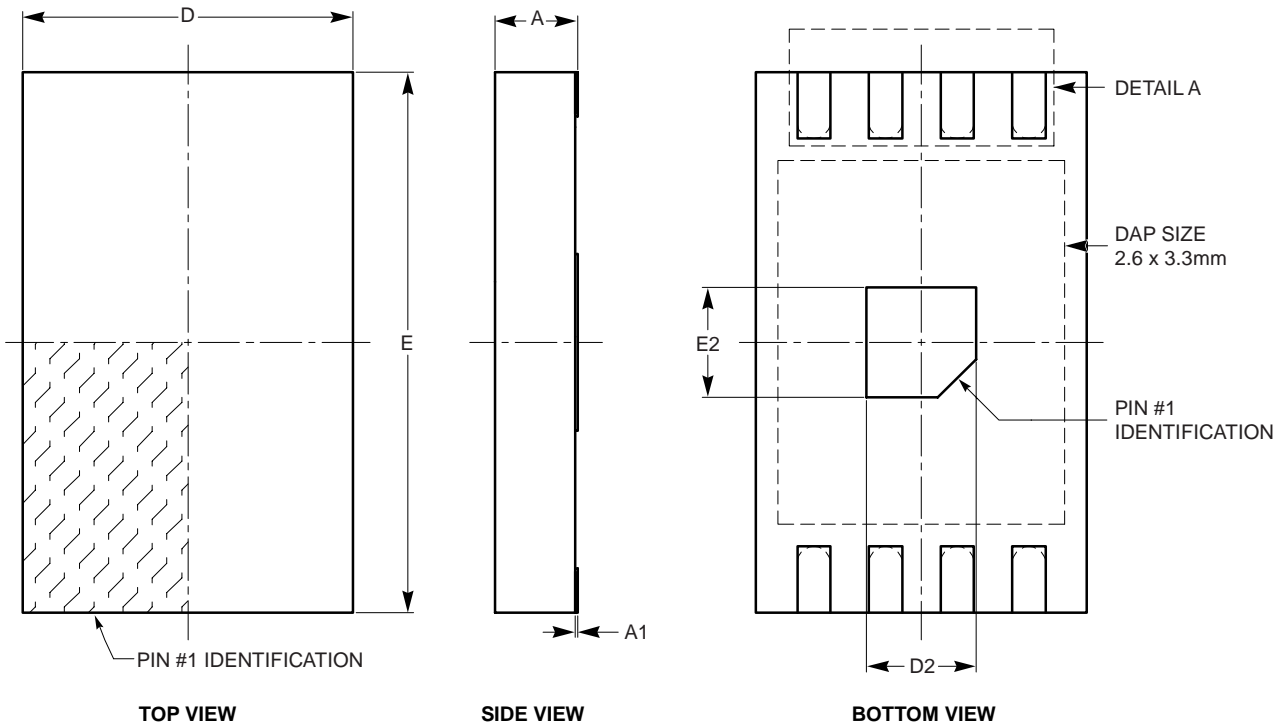

SYMBOL	MIN	NOM	MAX
A	0.70	0.75	0.80
A1	0.00	0.02	0.05
A2	0.45	0.55	0.65
A3	0.20 REF		
b	0.25	0.30	0.35
D	2.90	3.00	3.10
D2	0.90	1.00	1.10
E	4.80	4.90	5.00
E2	0.90	1.00	1.10
e	0.65 TYP		
L	0.50	0.60	0.70

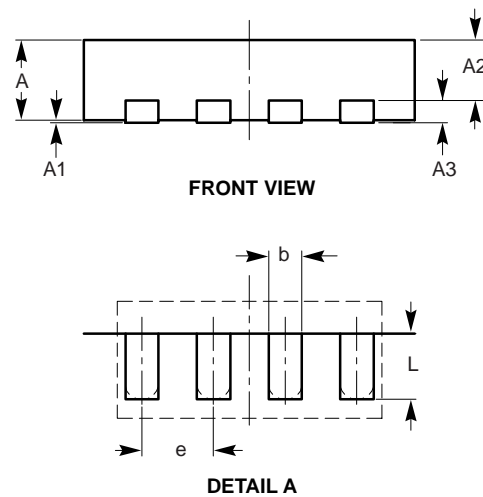

For current Tape and Reel information, download the PDF file from:
<http://www.catsemi.com/documents/tapeandreel.pdf>.

Notes:

- (1) All dimensions are in millimeters.
- (2) Complies with JEDEC standard MO-229.

TDFN 8-Pad 2 x 3mm (VP2)

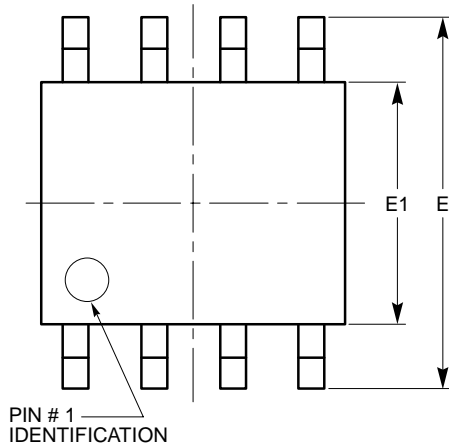

TOP VIEW

SYMBOL	MIN	NOM	MAX
A	1.35		1.75
A1	0.10		0.25
b	0.33		0.51
c	0.19		0.25
D	4.80		5.00
E	5.80		6.20
E1	3.80		4.00
e	1.27 BSC		
h	0.25		0.50
L	0.40		1.27
θ	0°		8°

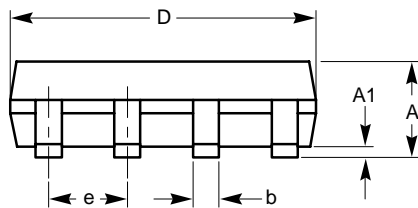

SIDE VIEW

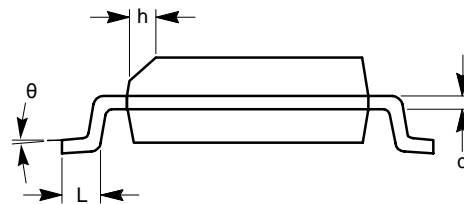

END VIEW

For current Tape and Reel information, download the PDF file from:
<http://www.catsemi.com/documents/tapeandreeel.pdf>.

Notes:

- (1) All dimensions are in millimeters. Angles in degrees.
- (2) Complies with JEDEC standard MO-229.

UDFN 8-Pad 2 x 3mm (HU3)

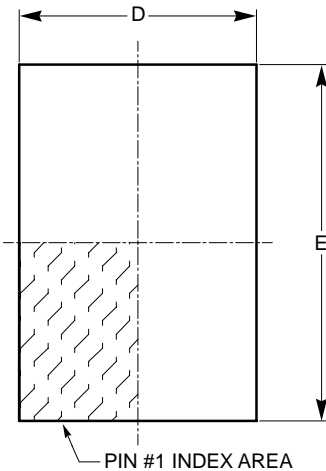

TOP VIEW

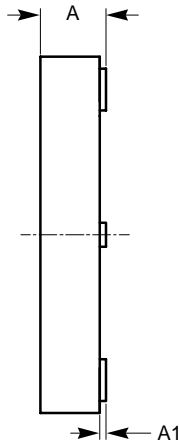

SIDE VIEW

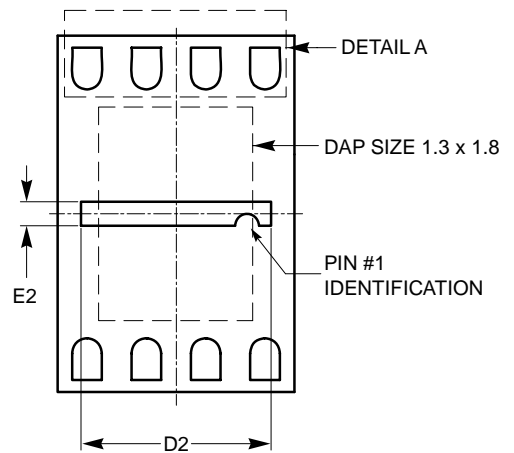

BOTTOM VIEW

SYMBOL	MIN	NOM	MAX
A	0.45	0.50	0.55
A1	0.00	0.02	0.05
A3	0.127 REF		
b	0.20	0.25	0.30
D	1.90	2.00	2.10
D2	1.50	1.60	1.70
E	2.90	3.00	3.10
E2	0.10	0.20	0.30
e	0.50 TYP		
K	0.10 REF		
L	0.30	0.35	0.40

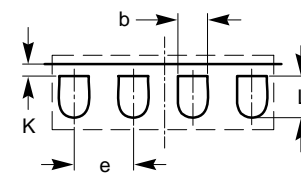

DETAIL A

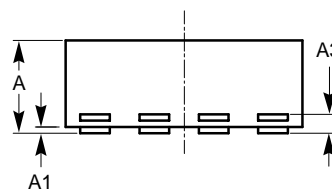

FRONT VIEW

For current Tape and Reel information, download the PDF file from:
<http://www.catsemi.com/documents/tapeandreeel.pdf>.

Notes:

- (1) All dimensions are in millimeters.
- (2) Complies with JEDEC standard MO-229.

EXAMPLE OF ORDERING INFORMATION

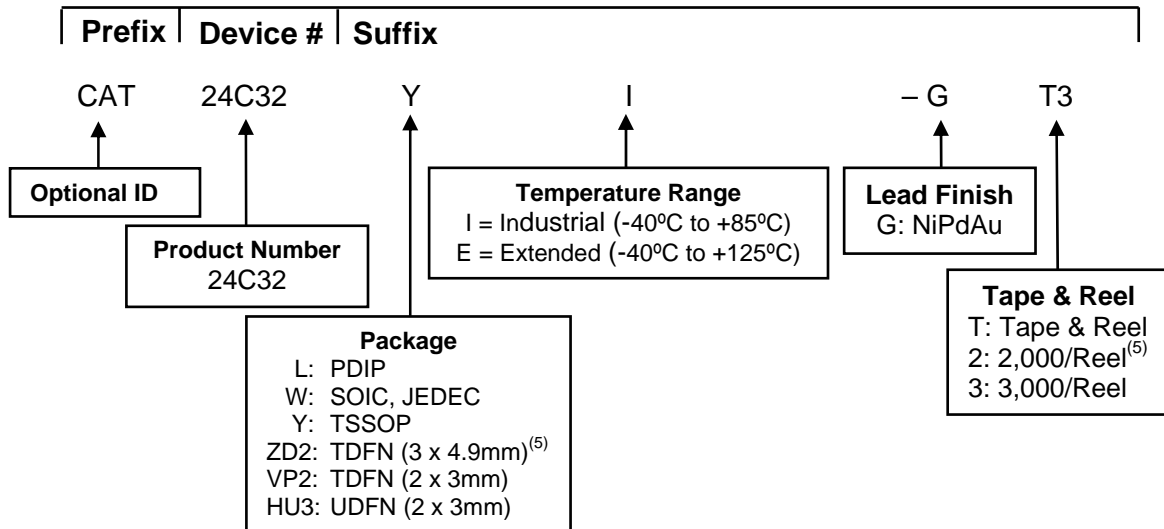

For Product Top Mark Codes, click here:
<http://www.catsemi.com/techsupport/producttopmark.asp>

Notes:

- (1) All packages are RoHS-compliant (Lead-free, Halogen-free).
- (2) The standard lead finish is NiPdAu.
- (3) The device used in the above example is a CAT24C32YI-GT3 (TSSOP, Industrial Temperature, NiPdAu, Tape & Reel, 3,000/Reel).
- (4) For additional package and temperature options, please contact your nearest ON Semiconductor Sales office.
- (5) TDFN, ZD2 is only available in 2,000 pcs/reel, i.e., CAT24C32ZD2I-T2. **The TDFN 3 x 4.9mm (ZD2) is not recommended for new designs.**

REVISION HISTORY

Date	Revision	Description
10/07/05	A	Initial Issue
11/15/05	B	Update Ordering Information Add Tape and Reel Specifications
02/02/06	C	Update Ordering Information
08/23/06	D	Updated device description, supporting text and figures, package outlines, package marking and ordering information. Updated and re-formatted D.C. Characteristics presentation. Updated and re-formatted A.C. Characteristics presentation to reflect Standard (100kHz) and Fast (400kHz) operation over the full voltage range.
09/08/06	E	Remove Package Markings
02/12/07	F	Update TDFN 8-Pad (3 x 4.9mm) package
03/20/07	G	Add TDFN 8-Pad (2 x 3mm) package
04/17/07	H	Add to Pin Configuration and Example of Ordering Information "Not Recommended for new design". Note for the ZD2 package. Update Pin Impedance Characteristics
06/27/07	I	Add Extended Temperature range Update D.C. Operating Characteristics table Update all Package Outline Drawing Add MD- to document number
03/26/08	J	Add UDFN 8-Pad package to Pin Configuration Update Features Update D.C. Operating Characteristics Update Pin Impedance Characteristics Update A.C. Characteristics Update Package Outline Drawings Add UDFN 8-Pad Package Outline Drawing Update Example of Ordering Information
24-Oct-08	K	Change logo and fine print to ON Semiconductor

ON Semiconductor and  are registered trademarks of Semiconductor Components Industries, LLC (SCILLC). SCILLC reserves the right to make changes without further notice to any products herein. SCILLC makes no warranty, representation or guarantee regarding the suitability of its products for any particular purpose, nor does SCILLC assume any liability arising out of the application or use of any product or circuit, and specifically disclaims any and all liability, including without limitation special, consequential or incidental damages. "Typical" parameters which may be provided in SCILLC data sheets and/or specifications can and do vary in different applications and actual performance may vary over time. All operating parameters, including "Typicals" must be validated for each customer application by customer's technical experts. SCILLC does not convey any license under its patent rights nor the rights of others. SCILLC products are not designed, intended, or authorized for use as components in systems intended for surgical implant into the body, or other applications intended to support or sustain life, or for any other application in which the failure of the SCILLC product could create a situation where personal injury or death may occur. Should Buyer purchase or use SCILLC products for any such unintended or unauthorized application, Buyer shall indemnify and hold SCILLC and its officers, employees, subsidiaries, affiliates, and distributors harmless against all claims, costs, damages, and expenses, and reasonable attorney fees arising out of, directly or indirectly, any claim of personal injury or death associated with such unintended or unauthorized use, even if such claim alleges that SCILLC was negligent regarding the design or manufacture of the part. SCILLC is an Equal Opportunity/Affirmative Action Employer. This literature is subject to all applicable copyright laws and is not for resale in any manner.

PUBLICATION ORDERING INFORMATION

LITERATURE FULFILLMENT:

Literature Distribution Center for ON Semiconductor
P.O. Box 5163, Denver, Colorado 80217 USA
Phone: 303-675-2175 or 800-344-3860 Toll Free USA/Canada
Fax: 303-675-2176 or 800-344-3867 Toll Free USA/Canada
Email: orderlit@onsemi.com

N. American Technical Support: 800-282-9855 Toll Free
USA/Canada

Europe, Middle East and Africa Technical Support:
Phone: 421 33 790 2910

Japan Customer Focus Center:
Phone: 81-3-5773-3850

ON Semiconductor Website: www.onsemi.com

Order Literature: <http://www.onsemi.com/orderlit>

For additional information, please contact your local
Sales Representative
